

A-A (1:1)

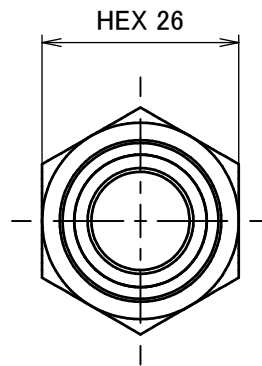
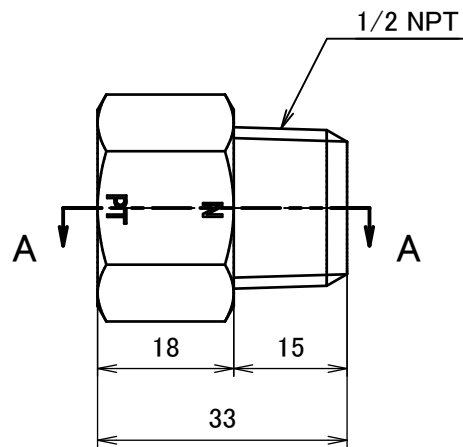
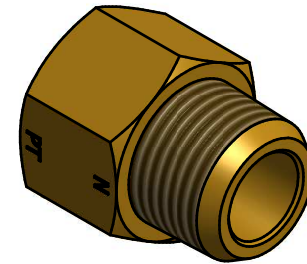
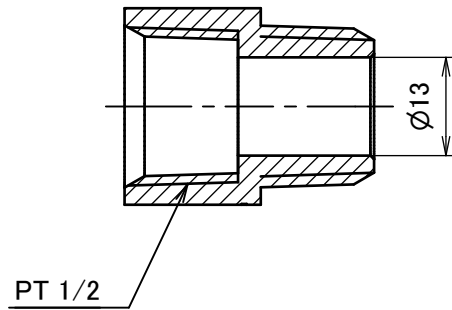

		第3角法	単位 mm	尺度 1:1	日付 2014/03/17
承認	mizuta	検図	mizuta	材質	C3604(cd75ppm以下)
設計	水田	製図	水田	備考	
				品名	NPT変換ソケット NF-3144
				図番	5NF-3144